

## Bridge Rectifiers

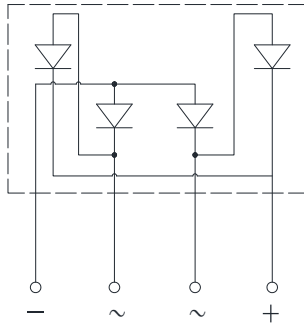
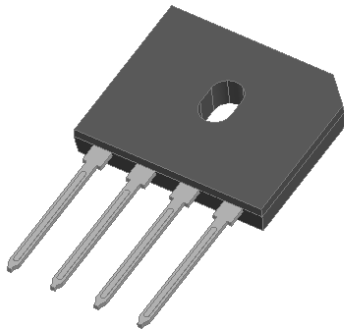

### Features

- UL recognition, file #E230084
- Glass passivated chip junction
- Ideal for printed circuit boards
- High surge current capability
- Solder dip 275 °C max. 7 s, per JESD 22-B106

### Typical Applications

General purpose use in AC/DC bridge full wave rectification for monitor, TV, printer, power supply, switching mode power supply, adapter, audio equipment, and home appliances applications.

### Mechanical Data

- **Package:** GBU  
Molding compound meets UL 94 V-0 flammability rating, RoHS-compliant
- **Terminals:** Tin plated leads, solderable per J-STD-002 and JESD22-B102
- **Polarity:** As marked on body

### ■Maximum Ratings (Ta=25°C Unless otherwise specified)

PARAMETER	SYMBOL	UNIT	GBU15005A	GBU1501A	GBU1502A	GBU1504A	GBU1506A	GBU1508A	GBU1510A
Device marking code			GBU15005A	GBU1501A	GBU1502A	GBU1504A	GBU1506A	GBU1508A	GBU1510A
Maximum Repetitive Peak Reverse Voltage	VRRM	V	50	100	200	400	600	800	1000
Maximum RMS Voltage	VRMS	V	35	70	140	280	420	560	700
Maximum DC blocking Voltage	VDC	V	50	100	200	400	600	800	1000
Average rectified output current @60Hz sine wave, R-load	With heatsink Tc =100°C	IO	A	15.0					
	Without heatsink Ta =25°C			3.2					
Forward Surge Current (Non-repetitive) @60Hz Half-sine wave, 1 cycle, Tj=25°C	IFSM	A	250						
Forward Surge Current (Non-repetitive) @1ms, square wave, 1 cycle, Tj=25°C			500						
Current squared time @1ms≤t≤8.3ms Tj=25°C, Rating of per diode	I²t	A²S	260						
Storage temperature	Tstg	°C	-55 ~ +150						
Junction temperature	Tj	°C	-55 ~ +150						
Dielectric strength @ Terminals to case, AC 1 minute	Vdis	KV	2.5						
Mounting torque @Recommend torque: 5kg·cm	Tor	kg·cm	8						



# GBU15005A THRU GBU1510A

## ■ Electrical Characteristics (T<sub>a</sub>=25°C Unless otherwise specified)

PARAMETER	SYMBOL	UNIT	TEST CONDITIONS	GBU15005A	GBU1501A	GBU1502A	GBU1504A	GBU1506A	GBU1508A	GBU1510A
Maximum instantaneous forward voltage drop per diode	V <sub>F</sub>	V	I <sub>FM</sub> =7.5A					1.0		
Maximum DC reverse current at rated DC blocking voltage per diode	I <sub>R</sub>	μA	T <sub>j</sub> =25°C					5		
			T <sub>j</sub> =125°C					100		
Typical junction capacitance	C <sub>j</sub>	pF	Measured at 1MHz and Applied Reverse Voltage of 4.0 V.D.C					80		

## ■ Thermal Characteristics (T<sub>a</sub>=25°C Unless otherwise specified)

PARAMETER		SYMBOL	UNIT	GBU15005A	GBU1501A	GBU1502A	GBU1504A	GBU1506A	GBU1508A	GBU1510A
Thermal Resistance	Between junction and ambient, Without heatsink	R <sub>θJ-A</sub>	°C/W					25.0		
	Between junction and case, With heatsink	R <sub>θJ-C</sub>						1.8		

Note: Device mounted on 75mm x 45mm x 5.5mm Aluminum Plate Heatsink.

## ■ Ordering Information (Example)

PREFERRED P/N	PACKING CODE	UNIT WEIGHT(g)	MINIMUM PACKAGE(pcs)	INNER BOX QUANTITY(pcs)	OUTER CARTON QUANTITY(pcs)	DELIVERY MODE
GBU15005A THRU GBU1510A	B1	Approximate 3.97	20	1000	2000	TUBE

## ■ Characteristics (Typical)

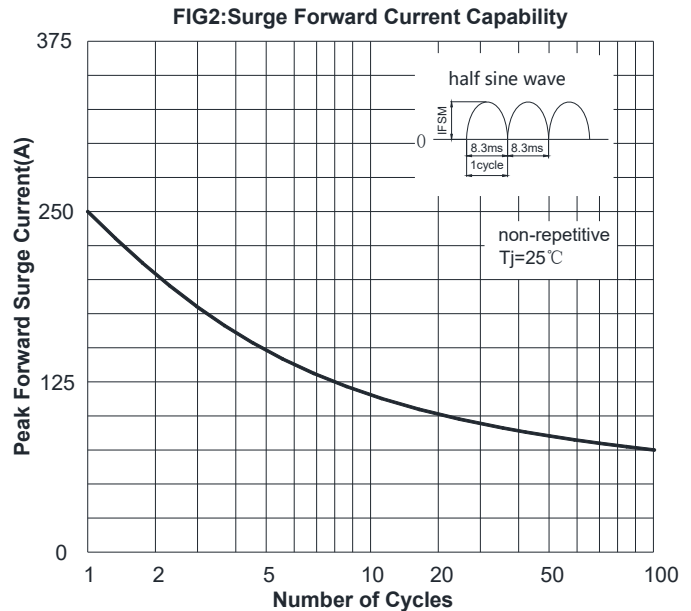
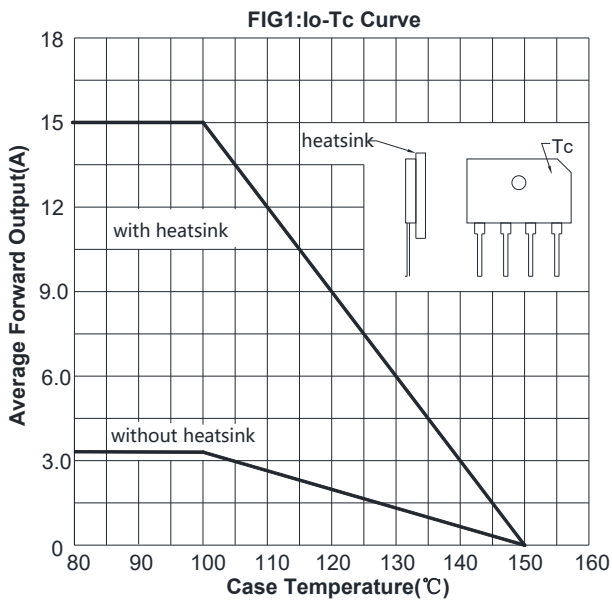



# GBU15005A THRU GBU1510A

FIG3: Typical Forward Voltage

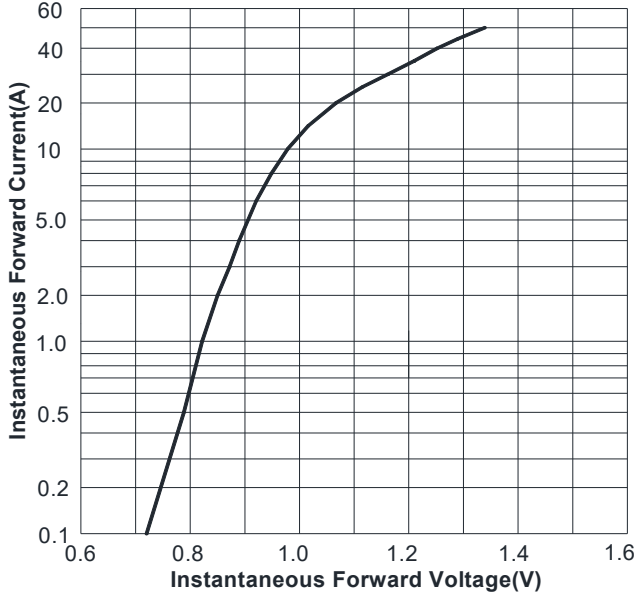
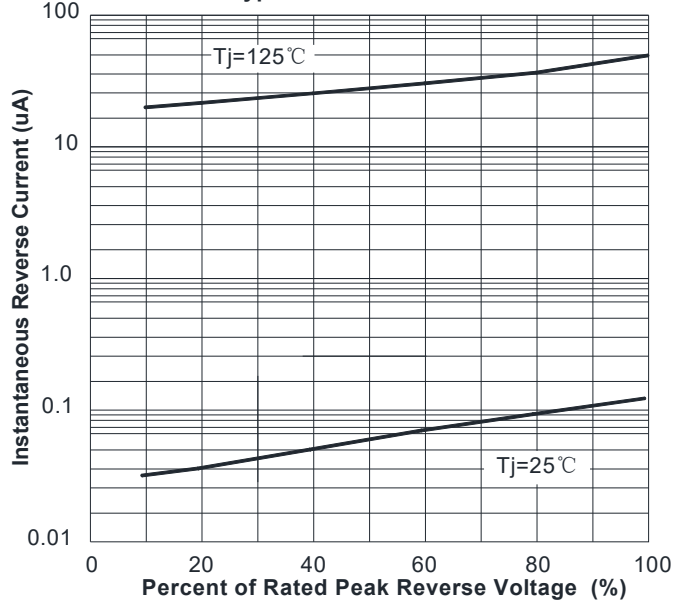
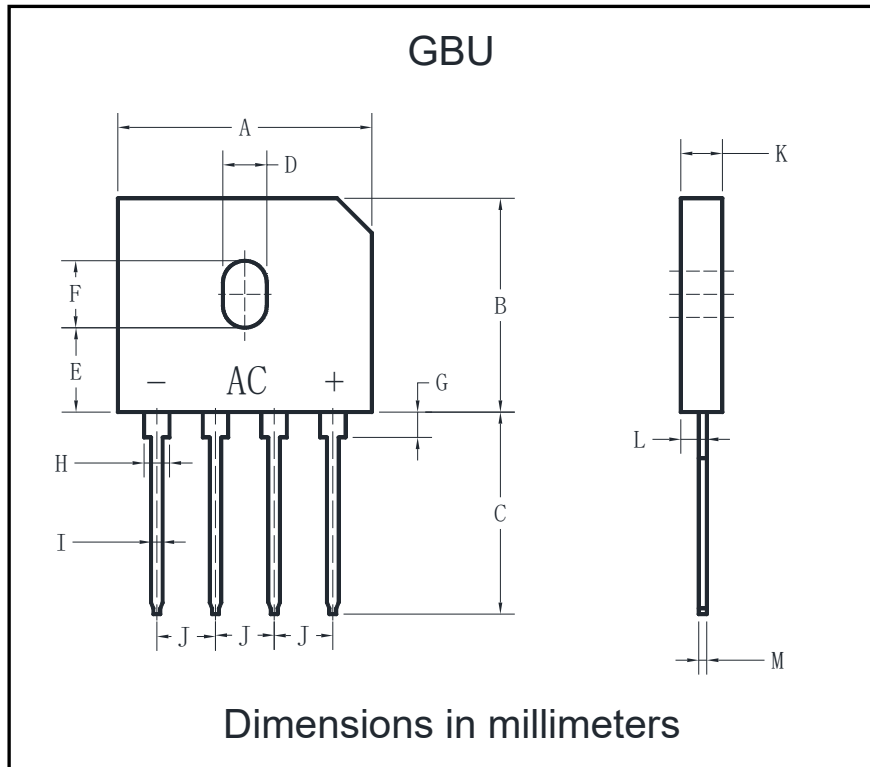

FIG4: Typical Reverse Characteristics



## ■ Outline Dimensions



GBU		
Dim	Min	Max
A	21.80	22.30
B	18.30	18.80
C	17.50	18.00
D	3.30	3.90
E	7.10	7.50
F	5.50	5.90
G	1.91	2.54
H	2.06	2.54
I	1.02	1.27
J	4.83	5.33
K	3.30	3.56
L	2.40	2.66
M	0.46	0.56



## GBU15005A THRU GBU1510A

---

### Disclaimer

The information presented in this document is for reference only. Yangzhou Yangjie Electronic Technology Co., Ltd. reserves the right to make changes without notice for the specification of the products displayed herein to improve reliability, function or design or otherwise.

The product listed herein is designed to be used with ordinary electronic equipment or devices, and not designed to be used with equipment or devices which require high level of reliability and the malfunction of which would directly endanger human life (such as medical instruments, transportation equipment, aerospace machinery, nuclear-reactor controllers, fuel controllers and other safety devices), Yangjie or anyone on its behalf, assumes no responsibility or liability for any damages resulting from such improper use of sale.

This publication supersedes & replaces all information previously supplied. For additional information, please visit our website [http:// www.21yangjie.com](http://www.21yangjie.com) , or consult your nearest Yangjie's sales office for further assistance.